

# GH300

电竞头戴耳机

GAMING HEADSET

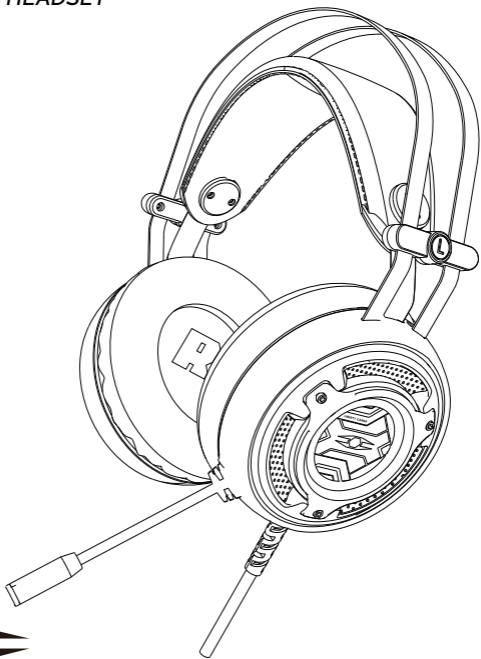

  
自由玩家™  
LIBERTY GAMER

用户手册  
USER MANUAL

## ■ Preface

Dear Customer,

Thank you for purchasing Liberty Gamer GH300 Gaming Headset. In order to better understand and use the product, please read this manual carefully. If you have any questions or suggestions, please contact our local dealer.

## ■ Features

- 7.1CH virtual surround to expand the sound field and bring the ultimate gaming immersion.
- Responsive  $\varnothing 50\text{mm}$  NdFeB-magnet drivers with wide frequency response and high dynamics.
- Integrated mic for clear in-game communication.
- Experience high-fidelity gaming audio, tackle enemies with pinpoint accuracy.
- About 16.8 million RGB colors to light up the vibes.
- Ergonomic, suitable for various kinds of head shapes.
- Adaptive suspension headband and soft skin-friendly earpads for long-wearing comfort.

## ■ Package Contents

Gaming Headset .....	1PC
User Manual .....	1PC

## ■ Application

PC/Mac with USB port

## ■ System Requirements

Windows7 or above, OS X 10.9 or later

## ■ Specifications

- Driver: dynamic
- Driver Diameter:  $\varnothing 50\text{mm}$
- Driver Impedance:  $32\Omega \pm 15\%$
- Headset Frequency Response: 20Hz-20kHz
- Headset Sensitivity:  $103 \pm 3\text{dB}$
- Rated Power: 20mW
- Peak Power: 30mW
- Polar Pattern: omnidirectional
- Mic Sensitivity:  $-42 \pm 3\text{dB}$
- Connection Cable:  $\varnothing 4.2\text{mm} \times 2.5\text{m}$
- Connector Type: USB
- Weight: about 380g

Note: The above data are measured by Takstar laboratory, and Takstar has the final interpretation right!

## ■ Operation Instructions

### 1. FUNCTION

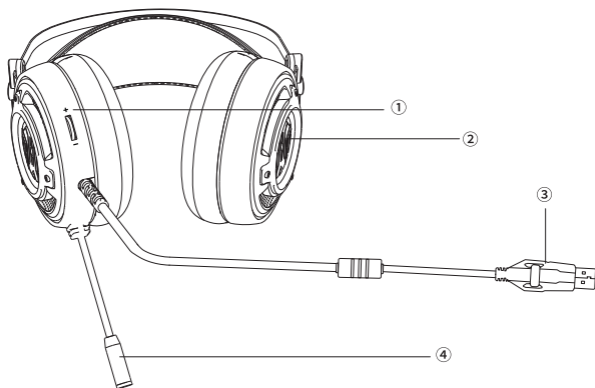

- ① Volume Knob: turn towards [+] to increase volume level,  
or towards [-] to decrease
- ② RGB Lighting
- ③ USB Cable
- ④ Integrated Mic

## 2. DEVICE CONNECTION

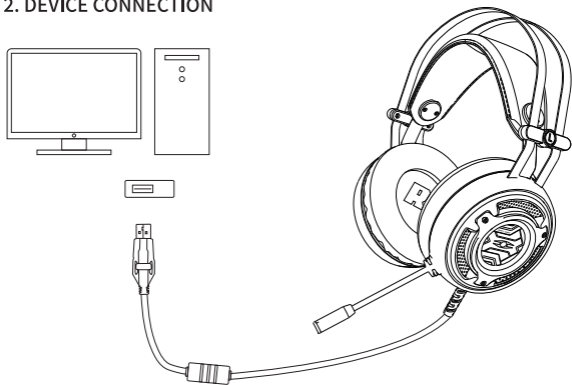

Connect the headset to the computer USB port via the included cable.

Note: The USB port should be a high power interface (USB2.0 or above). USB ports on old-style keyboard and display may not support high-power devices.

## 3. DRIVER INSTALLATION

Please download the driver from [www.libertygamer.com](http://www.libertygamer.com).

By using the driver software, you can gain full access to:

Headset audio settings

Microphone audio settings

7.1 Surround settings

(Can be installed on PC running Windows 7 or later)

Note: To use 7.1 Surround, you must enable it in the driver software.

Otherwise the headset uses stereo mode by default.

## 4. SYSTEM SETTINGS

Windows:

Navigate to Control Panel → Hardware and Sound → Sound, and set “LIBERTY GAMER-GH300” as default device under both Playback and Recording tabs.

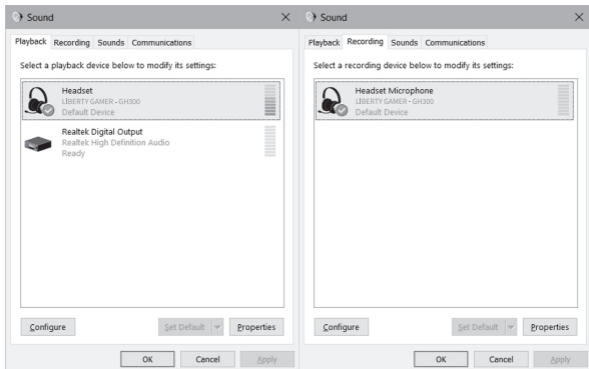

Mac:

Navigate to System Preferences → Sound, and select “LIBERTY GAMER-GH300” under both Input and Output tabs.

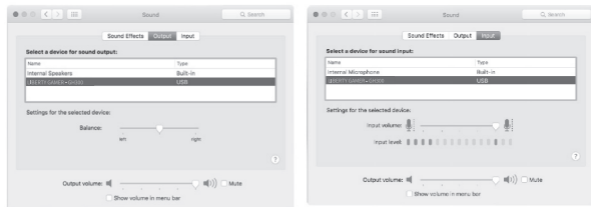

## ■ Correct Operation

For safe and comfortable operation, please read carefully and abide by the following items:

1. To avoid hearing loss, set the volume of the player to minimum before connecting the headset. After putting the earphone on, increase the volume to a proper level. Noise is measured in decibels (dB). Any outside noise of 85 decibels or more will cause gradual hearing loss.
2. Please pay attention to your operation habits! Volume and duration are proportional to hearing loss. The higher the volume, the shorter the time you should listen; the more comfortable the volume is, the longer you can listen. Listening at high volume for long will cause damage to your hearing. This dB level chart compares some common noise sources and their potential danger to your hearing:

Sound Source	Noise Level	Consequence on Hearing
Whisper	30dB	Very quiet
Quiet office	50-60dB	Comfortable hearing level is below 60dB
Vacuum cleaner /hair dryer	70dB	Somewhat invasive and may interfere with phone calls
Food processor	85-90dB	85dB (continuously 8 hours) will begin to hurt hearing
Garbage cleaning machine/ cement mixer	100dB	Exposure to sound of 90~100dB is suggested to be within 15 minutes if without protection
Electric saw /electric drill	110dB	Frequent exposure to over 100dB for more than 1 minute can impair hearing
Rock concert (subjective)	110-140dB	Painful hearing starts at about 120dB





## ■ Maintenance

1. The rated power of this headset is 20mW. Please do not operate it at overload status to avoid damage.
2. Please keep it in a dry and clean environment. During operation, prevent damage from water ingress, drop or collision.
3. Operating the headset in high temperature or high humidity for long can lead to device damage or shortened service life.
4. Keep the headset away from strong magnet to avoid demagnetizing and decreased sensitivity and performance.
5. Do not use strong chemical or detergent for cleaning.
6. Do not scratch the product surface with sharp objects.
7. Store in a clean, dry area if not used for a long period. Keep and use away from areas of high temperature and humidity.
8. Do not disassemble or repair the product by yourself to avoid injury. If you have any questions or require any services, please contact our local seller.





## ■ Cautions

### DANGER

<ul style="list-style-type: none"><li>• To ensure your personal safety, do not wear or place the headset too close to the pacemaker (less than 10cm).</li></ul>	 Prohibition
<ul style="list-style-type: none"><li>• Do not insert the cable plug into live power socket.</li></ul>	 Prohibition
<ul style="list-style-type: none"><li>• For your safety and the safety of other traffic participants, do not use the headset while driving a vehicle, riding a bicycle or walking on the road.</li></ul>	 Implementation
<ul style="list-style-type: none"><li>• Keep away from fire to avoid explosion.</li></ul>	 Prohibition

### WARNING

<ul style="list-style-type: none"><li>• Not a toy. Children should not use without adult supervision.</li></ul>	 Implementation
<ul style="list-style-type: none"><li>• Abide by relative safety rules during operation. Do not use it if prohibited by laws and regulations to avoid accident.</li></ul>	 Implementation

## ■ Label Meanings



This symbol indicates that this product should not be disposed of with your household waste, according to the WEEE directive (2012/19/EU) and your national law. This product should be handed over to an authorized collection site for recycling waste electrical and electronic equipment (WEEE). Improper handling of this type of waste could have a possible negative impact on the environment and human health due to potentially hazardous substances that are generally associated with WEEE. At the same time, your cooperation in the correct disposal of this product will contribute to the effective usage of natural resources. For more information about where you can drop off your waste equipment for recycling, please contact your local city office, waste authority, or your household waste disposal service.

## ■ About This Manual

This manual contains up-to-date technical specifications as of printing. However, specifications contained herein may not conform to your particular product since Liberty Gamer is constantly improving its products. Also, specifications, devices or accessories available may vary from region to region. If you have any questions, please contact our local dealer. For the latest version/more information, please visit our website: [www.libertygamer.com](http://www.libertygamer.com)

Copyright © 2022 TAKSTAR. TAKSTAR, LIBERTY GAMER, 得胜, 自由玩家 and their respective logos are registered trademarks or trademarks of Guangdong Takstar Electronic Co., Ltd. in the PRC, and/or other countries. All other trademarks are the property of their respective owners.

产品中有毒有害物质或元素的名称及含量标识表

部件名称	有毒有害物质或元素					
	铅 (Pb)	汞 (Hg)	镉 (Cd)	六价铬 (Cr(VI))	多溴联苯 (PBB)	多溴二苯醚 (PBDE)
塑料部件	○	○	○	○	○	○
金属部件	×	○	○	○	○	○
电路板组件	×	○	○	○	○	○
线缆	×	○	○	○	○	○

本表格依据SJ/T 11364的规定编制。

○: 表示该有害物质在该部件所有均质材料中的含量均在 GB/T 26572 规定的限量要求以下。

×: 表示该有害物质至少在该部件的某一均质材料中的含量超出 GB/T 26572 规定的限量要求。

此标志为产品的环保使用期限标志，

且此环保使用期限只适用于产品正常工作的温度和湿度等条件。



## 注意事项:

1. 本单为保修凭证, 请用户妥善保管, 如有遗失, 恕不保修或退换。
2. 保修期限制: 购买之日起十二个月内。
3. 除了不可抗力事件损坏外, 由本公司负责, 免费维修。
4. 如属保管不善或使用不当造成的损坏, 维修点将酌情收费。
5. 擅自拆卸维修者, 不予保修。
6. 以上保修条款仅限于中国市场适用 (不含港澳台地区)。

# 产品服务保证书

姓名: \_\_\_\_\_ 电话: \_\_\_\_\_ 地址: \_\_\_\_\_

商品: \_\_\_\_\_ 型号: \_\_\_\_\_ 购买日期: \_\_\_\_\_ 年 \_\_\_\_ 月 \_\_\_\_ 日

维修记录栏 (由维修员填写)	维修员签名	日期

◆ 广东得胜电子有限公司 ◆ 电话: 400-6828-333 ◆ 地址: 广东省惠州市博罗县龙溪街道富康一路2号



**广东省电声工程技术研究开发中心  
广东得胜电子有限公司制造**

地址：广东省惠州市博罗县龙溪街道富康一路2号

全国服务热线：400 6828 333

邮箱：liberty.gamer@takstar.com

网址：www.libertygamer.com

Guangdong Takstar Electronic Co., Ltd.

Address: No. 2 Fu Kang YiRd., Longxi Boluo

Huizhou, Guangdong 516121 China

Tel: 86 752 6383644 Fax: 86 752 6383952

Email: sales@takstar.com

Website: www.libertygamer.com

GB/T 14471-2013  
9TGH300BS1A